

A. **USA** versions

- a) Arrangement of components
- b) Without fault diagnosis by measuring on/off ratio
- c) With fault diagnosis by measuring on/off ratio
- d) On-board diagnosis system California (function and test)
- e) Troubleshooting table
- f) Electrical test data of CIS-E injection system
- g) Special tools, commercial testers
- h) Connecting testers according to connection diagram
- i) Pin assignment of CIS-E control unit connector (N3)
- j) Test routine with contact box
- l) Table of voltage levels of EZL/CIS-E coolant temperature sensor (B11/2)
- m) Testing 4-pole coolant temperature sensor (B11/2)
- n) Testing connector of 4-pole coolant temperature sensor (B11/2)
- o) Altitude sensor table (B18)
- p) Testing decel fuel cutoff
- q) Testing road speed signal

a) Arrangement of components
Model 107

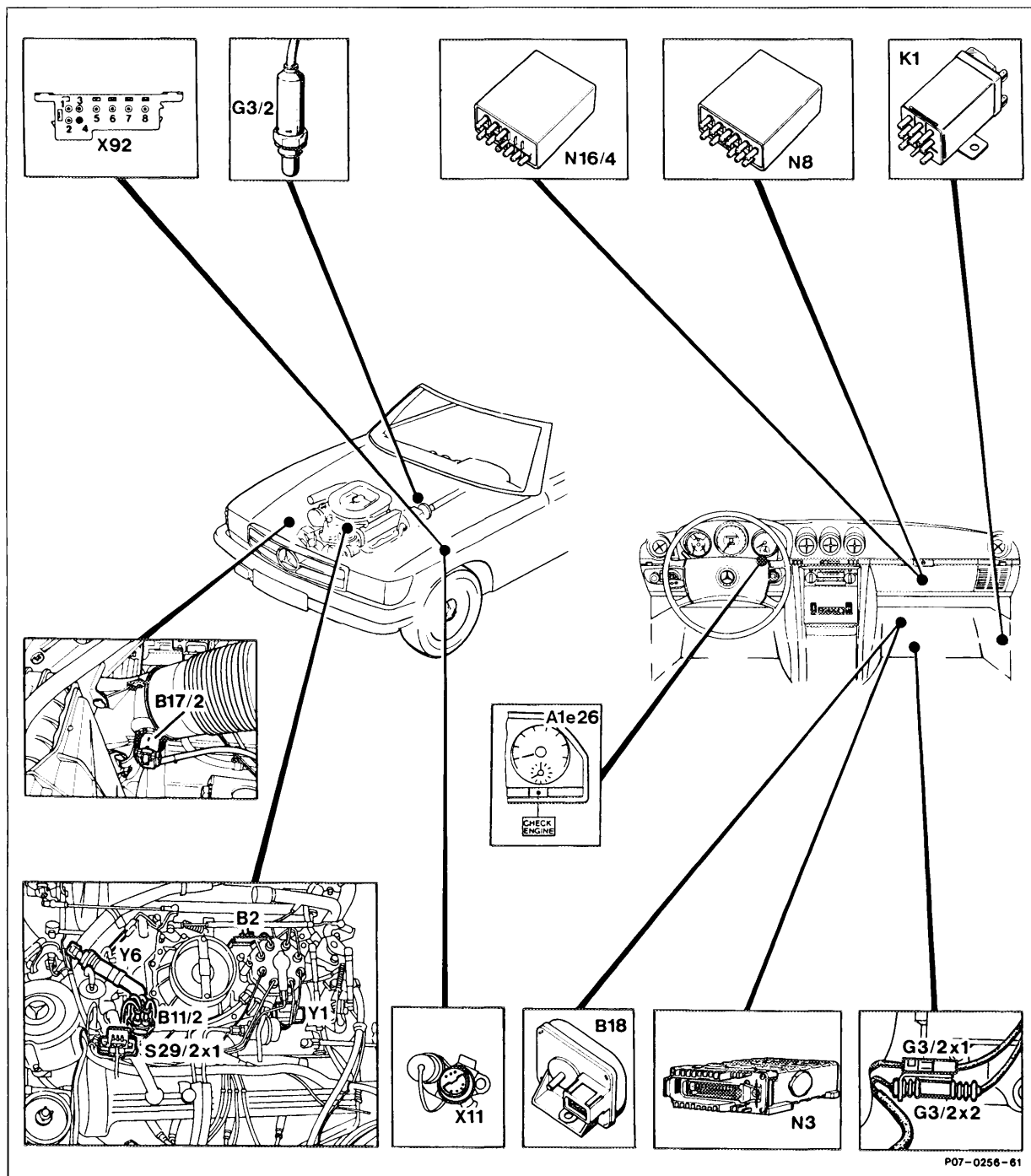

P07-0256-61

- A1e26 "CHECK ENGINE" warning lamp
- B2 Air flow sensor position indicator
- B11/2 Coolant temperature sensor (EZL/CIS-E)(2-pole)
- B18 Altitude correction capsule
- G3/2 Heated O₂-sensor
- G3/2x1 Connector, O₂-sensor heater coil (2-pole)
- G3/2x2 Connector, O₂-sensor signal (1-pole)
- K1 Overvoltage protection relay (5-pole)
- N3 CIS-E control unit

- N8 Idle speed control unit
- N16/4 Fuel pump relay with kickdown cut-out
- S29/2x1 Connector, throttle valve switch, full load/idle
- X11 Diagnostic socket/terminal block (circuit TD)
- X92 Test connection for diagnosis (impulse readout, 8-pole) (---X11/4---)
- Y1 Electrohydraulic actuator (EHA)
- Y6 Idle speed air valve

Model 126

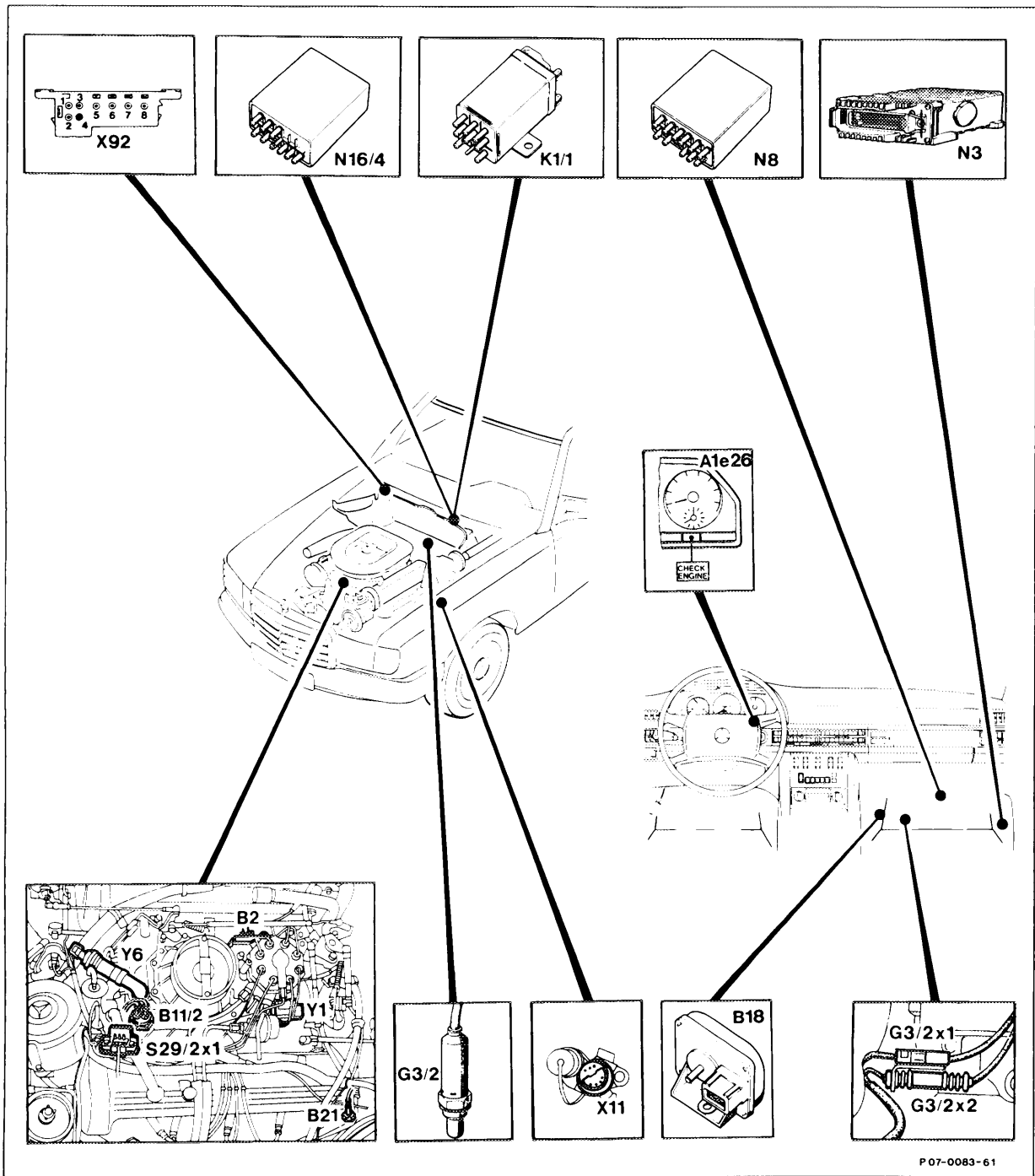

- | | | | |
|--------|--|---------|---|
| A1e26 | "CHECK ENGINE" warning lamp | N8 | Idle speed control unit |
| B2 | Air flow sensor position indicator | N16/4 | Fuel pump relay with kickdown cut-out |
| B11/2 | Coolant temperature sensor (EZL/CIS-E)(2-pole) | S29/2x1 | Connector, throttle valve switch, full load/idle |
| B18 | Altitude correction capsule | X11 | Diagnostic socket/terminal block (circuit TD) |
| B21 | EGR temperature sensor | X92 | Test connection for diagnosis (impulse readout, 8-pole) (---X11/4---) |
| G3/2 | Heated O ₂ -sensor | Y1 | Electrohydraulic actuator (EHA) |
| G3/2x1 | Connector, O ₂ -sensor heater coil (2-pole) | Y6 | Idle speed air valve |
| G3/2x2 | Connector, O ₂ -sensor signal (1-pole) | | |
| K1/1 | Overvoltage protection relay, 87E (7-pole) | | |
| N3 | CIS-E control unit | | |

b) Without fault diagnosis by measuring on/off ratio

Up to 12/85 (production date 552) no fault detection integrated in CIS-E control unit.

On these cars, it is not possible to enter the test routine through measuring the on/off ratio.

In this case, perform the same test routine, without % readout, Section "i", test routine with contact box.

c) With fault diagnosis by measuring on/off ratio

Effective 12/85, faulty input signals are detected by the CIS-E control unit (N3) and passed to the lambda test output. The faults detected can be output with the lambda control tester (012) at diagnostic socket (X11).

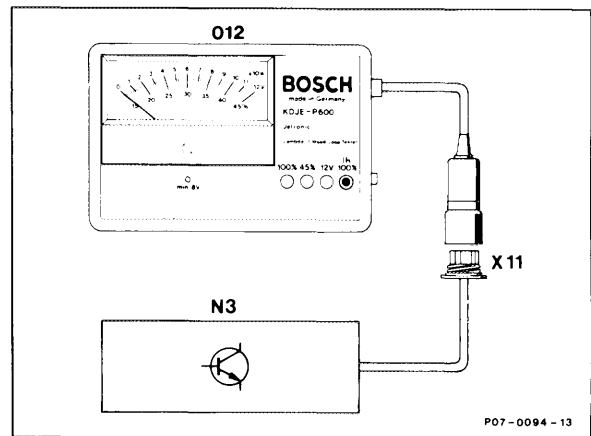

The fault detection facility enables various components of the CIS-E injection system to be tested by measuring the on/off ratio.

Detection of control units:
Connect lambda control tester.
Switch on ignition.

On/off ratio readout	Control unit
70%	with fault detection
100%	without fault detection
85%	California

Wiring diagrams 07.3-128.

d) On-board diagnosis system California

All exhaust emission-relevant components of the CIS-E injection system and of the exhaust gas recirculation system are monitored by the CIS-E control unit. Malfunctions resulting from open circuits or failure of one of these components are indicated by the "CHECK ENGINE" indicator lamp in the instrument cluster and at the same time stored in the CIS-E control unit.

Note

Pushbutton switch and LED have been developed to enable customer and independent repair facilities to specifically pinpoint the fault path in conformity with the legislation relating to "On-board means". A pulse counter has been developed for MB workshop personnel which presents a readout of the stored fault(s) on a digital display.

The control unit is switched over to on/off ratio output for testing the lambda control by pressing the pushbutton switch (refer to Testing lambda control (07.3-105)).

The on/off ratio is output only after the CIS-E control unit has been programmed to on/off ratio output. Otherwise the readout shows 0 % or 85 %, respectively, when the "CHECK ENGINE" indicator lamp lights up, with the engine running.

A test connector (X92) with pushbutton switch (2) and LED (4) is provided on the component compartment partition wall of Model 126 and on the left wheel house (ill.) of Model 107. When the pushbutton switch is operated (ignition: ON) for between 2 and 4 seconds, the flashing pulse output is initiated and the fault path indicated by the number of flashes.

Fault detection table

No. of flashing pulses	Fault path
1	No fault in system
2	Throttle valve switch, full throttle contact
3	Coolant temperature sensor
4	Air flow sensor potentiometer
5	O ₂ sensor
6	Not assigned
7	TD signal
8	Altitude correction sensor
9	Electrohydraulic actuator
10	Throttle valve switch, idle contact
11	Not assigned
12	Exhaust gas recirculation

Model 107

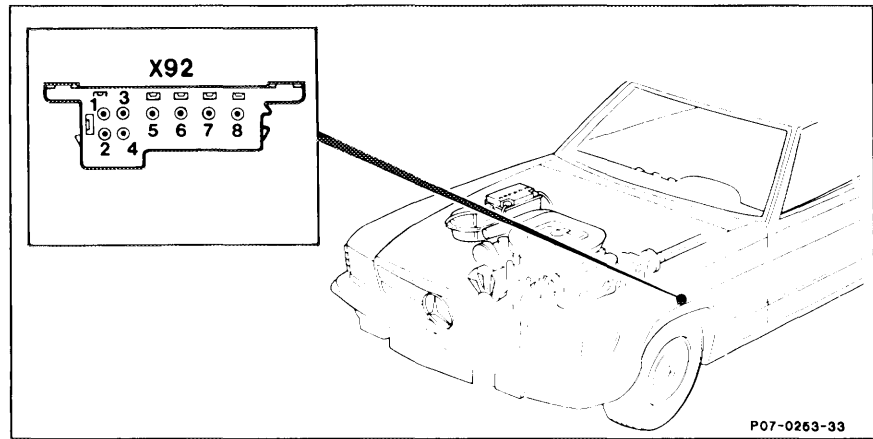

Model 126

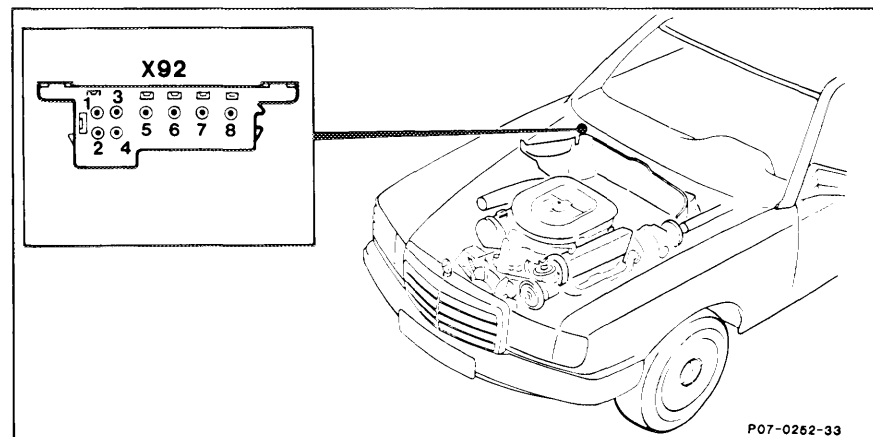

Testing on-board diagnosis with pulse counter

Complaint:
"CHECK ENGINE" indicator lamp in instrument cluster lights up.

Test conditions:
Battery, overvoltage protection relay and control unit must not be disconnected prior to and during the test otherwise the stored fault is erased.
Battery voltage 11 – 14 Volts.

Notes regarding pulse readout

The digit 1 indicates that no fault is stored in the system. All other digits are assigned to a particular fault. If several faults exist in the system, the fault with the lowest pulse number is output first.

The digits from 1 – 12 appear on the pulse counter display.

- If the LED U Batt lights up after connecting the counter, pulse counter and power supply for pulse counter are in proper order.
- If no further display appears during the test after one or several pulse readouts (digits), there is no further fault stored in the system.

Testing

- Connect pulse counter according to connection diagram.
- Switch on ignition.

Note

LED U Batt in display panel must light up; if not:

Multimeter set to Volts:

- a) Test contact 1 on test connector X92 to battery positive (11 – 14 V).
- b) Test contact 3 on test connector X92 to contact 1 (0.7 – 2.5 V).

- 001 CIS-E control unit connector
- 002 Test cable
- 003 Multimeter
- 004 Contact box
- N3 CIS-E control unit

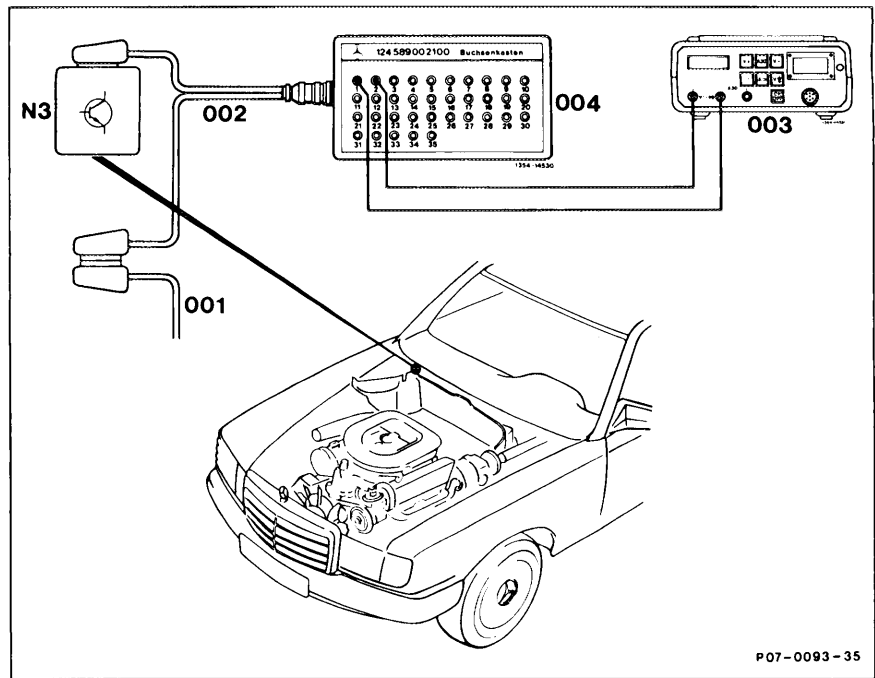

Pulse readout

- Press start button for between 2 and 4 seconds.
- Take readout of number of pulses and note.
- Press start button once again for between 2 and 4 seconds, note any further faults. If no further fault is stored in the system, no display appears after this.
- Rectify noted faults (pulse readout) according to troubleshooting table by connecting contact box according to connection diagram.

After completion of flashing pulse readout, the LED shows a steady light. If the pushbutton switch is again pressed for between 2 and 4 seconds, any further fault path stored can be indicated. If no further fault is detected, the CIS-E control unit switches over to on/off ratio output.

Erasing fault memory

Once a fault has been rectified without the CIS-E control unit having been disconnected, the pulse indicated must be erased as follows:

- After the pulse readout has been indicated for a waiting period of 2 seconds, press start button for 6 – 8 seconds.

Note

Each pulse indicated must be erased separately.

- No readout indicates that stored fault has been erased.
- If a digit (> 1) is indicated, there are further faults in the system.

Special tools

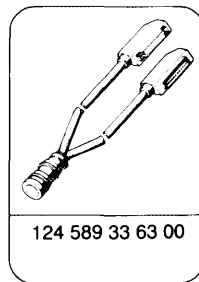
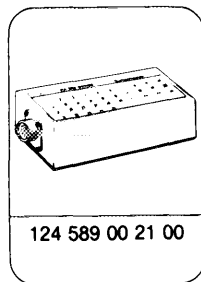
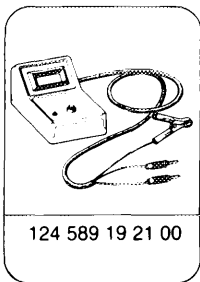

Commercial tester

Multimeter

e. g. Sun, DMM-5

Model 107

- 013 Pulse counter
- T1 Ignition coil
- X92 Diagnostic test connector, 8-pin (flashing code)

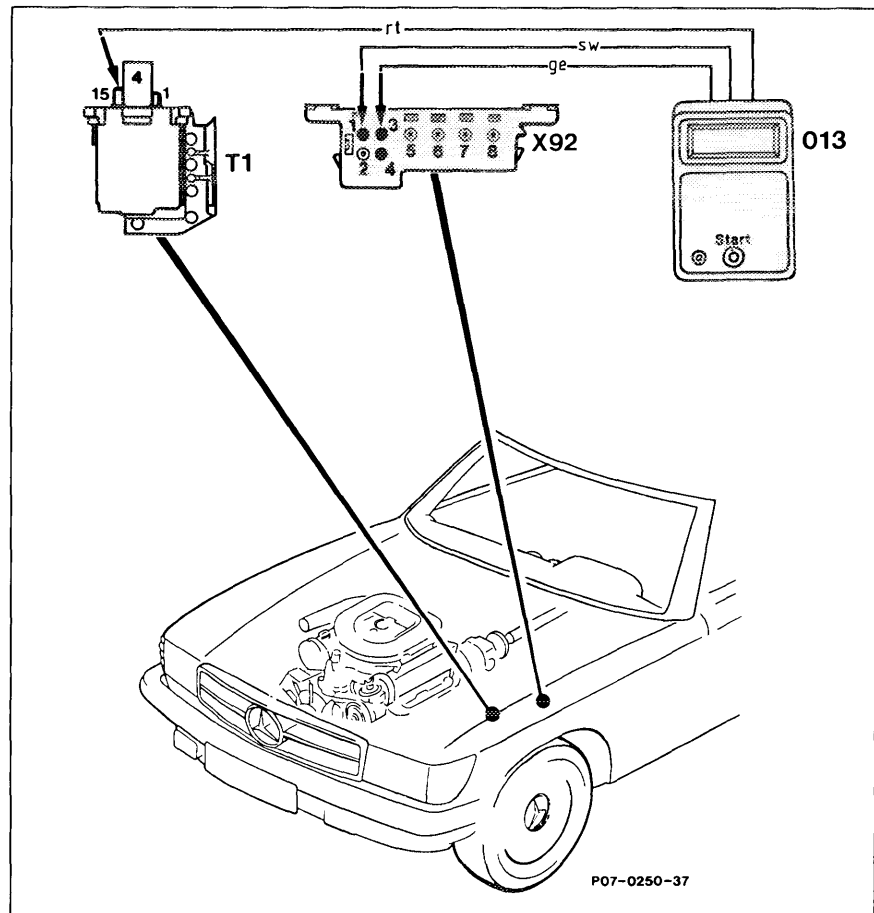

P07-0250-37

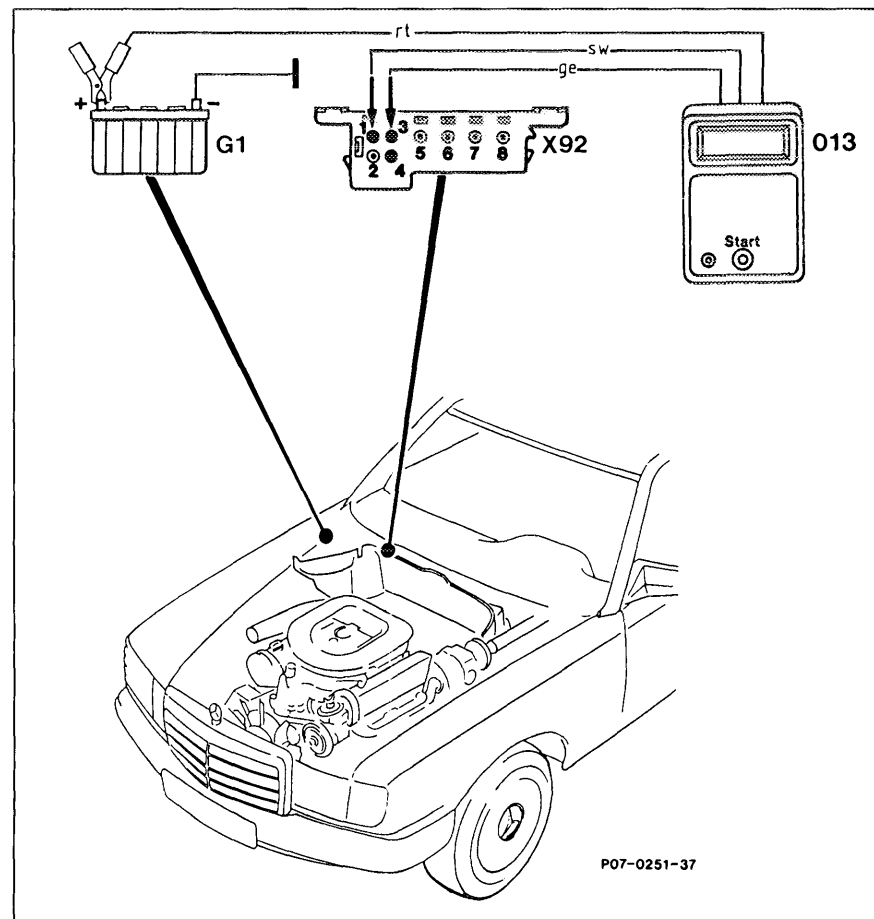

Model 126

- 013 Pulse counter
- G1 Battery
- X92 Diagnostic test connector, 8-pin (flashing code)



P07-0251-37







Troubleshooting table "On-board diagnosis"

Test connection:	Operation/Requirement	Specification	Possible cause/Remedy
 Contact box			
 Multimeter			







Pulse readout 1



-	-	-	No fault in system
---	---	---	--------------------

Pulse readout 2







Full throttle contact  2  5	Ignition: OFF Connector at CIS-E control unit and connector at electronic ignition control unit (code number 1 - 4) disconnected Accelerator at full throttle	∞ $< 1 \Omega$	Full throttle contact, wiring
2  3	Detach connector S29/2x Accelerator at full throttle	∞ $< 1 \Omega$	
Wiring  5  3	Detach connector S29/2x	$< 1 \Omega$	Open circuit
W11  2		$< 1 \Omega$	Open circuit

Pulse readout 3





Coolant temperature sensor  7  21	Ignition: OFF Connector at CIS-E control unit disconnected	refer to table "I"	Coolant temperature sensor, wiring
 refer to Section "m"	Detach connector at temperature sensor	refer to table "I"	Renew coolant temperature sensor
Wiring  21  21	Connector at electronic ignition control unit (code numbers 1 - 4) disconnected	$< 1 \Omega$	Open circuit
 7  21		$< 1 \Omega$	Open circuit



Test connection:	Operation/Requirement	Specification	Possible cause/Remedy
 Contact box  Multimeter			

Pulse readout 4

Air flow sensor potentiometer		Engine idling at normal operating temperature, CIS-E control unit connected	4.5 – 5.5 V	Air flow sensor potentiometer, altitude correction sensor (refer to pulse readout 8) CIS-E control unit
7		18		
7		17	0.5 – 1.5 V	Air flow sensor potentiometer, CIS-E control unit
1	B2 	3	3.6 – 4.4 kΩ	
1	B2 	2	Ω level rises continuously up to half of deflection and then drops off again	Renew air flow sensor
Wiring		Measure at connector B2	< 1 Ω	Open circuit
7		B2 1		
18		B2 3	< 1 Ω	Open circuit
17		B2 2	< 1 Ω	Open circuit

Pulse readout 5



O ₂ sensor		Engine idling at normal operating temperature, CIS-E control unit connected	fluctuates between 0.1 – 0.9 V	O ₂ sensor, wiring
7		8		
7		G3/2x2	450 mV	Renew O ₂ sensor
Wiring		Ignition: OFF Detach connector at CIS-E control unit	∞	Wiring faulty
7		8		
8		G3/2x2	< 1 Ω	Open circuit

Test connection:	Operation/Requirement	Specification	Possible cause/Remedy
 Contact box  Multimeter			





Pulse readout 6



not assigned	-	-	-
--------------	---	---	---

Pulse readout 7

TD signal			
2		25	Engine idling at normal operating temperature, CIS-E control unit connected
			6 – 11 V
			Ignition control unit, wiring
Wiring			
25		N8 10	Ignition: OFF Disconnect idle speed control unit N8
			< 1 Ω
			Open circuit

Pulse readout 8



Altitude correction sensor			
7		18	Ignition: ON CIS-E control unit connected
			4.6 – 5.5 V
			Altitude correction sensor, air flow sensor potentiometer, refer to pulse readout 4, wiring of CIS-E control unit
7		11	
			refer to table "o"
			Altitude correction sensor, wiring
Wiring			
7		B18 3	Ignition: OFF Detach connector at B18
			< 1 Ω
			Open circuit
18		B18 2	
			< 1 Ω
			Open circuit
11		B18 1	
			< 1 Ω
			Open circuit

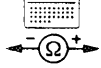
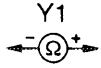
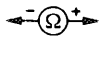
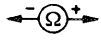

Test connection:	Operation/Requirement	Specification	Possible cause/Remedy
 Contact box  Multimeter			

Pulse readout 9

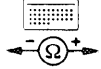
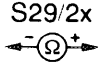
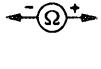
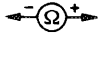
Electrohydraulic actuator		Ignition: OFF	Specification	Possible cause/Remedy
10		Connector at CIS-E control unit detached	$19.5 \pm 1 \Omega$	Electrohydraulic actuator, wiring
1		Detach connector Y1	$19.5 \pm 1 \Omega$	Renew electrohydraulic actuator
Wiring				
10			$< 1 \Omega$	Open circuit
12			$< 1 \Omega$	Open circuit

Pulse readout 10





Idle contact		Ignition: OFF	Specification	Possible cause/Remedy
2		Connector at CIS-E control unit and idle speed control unit N8 disconnected	$< 1 \Omega$	–
		Depress accelerator	∞	Idle contact, wiring
		Detach connector S29/2x	$< 1 \Omega$	
1		Depress accelerator	∞	Set or renew throttle valve switch
Wiring				
13			$< 1 \Omega$	Open circuit
N8			$< 1 \Omega$	Open circuit
S29/2x			$< 1 \Omega$	Open circuit

Test connection:	Operation/Requirement	Specification	Possible cause/Remedy
 Contact box  Multimeter			

Pulse readout 11

not assigned	-	-	-
--------------	---	---	---

Pulse readout 12

Exhaust gas recirculation temperature sensor 			
7  19 Run engine at normal operating temperature for approx 1 min at 4000 rpm		< 4.7 V	Exhaust gas recirculation temperature sensor, EGR valve, wiring
EGR valve	-	-	refer to testing EGR
Wiring 			
19  X80/3 X80/3 separated		< 1 Ω	Open circuit
7  X80/2 X80/2 separated		< 1 Ω	Open circuit, wiring in order, renew EGR temperature sensor.

e) Troubleshooting table

Note

This test should be performed if a complaint is received regarding engine running, e. g. rough idle. Display fluctuates, no fault in system.

Test condition:

Battery voltage 11 – 14 V

Engine should be idling and engine oil temperature approx. 80 °C for measuring on/off ratio.

On/off ratio in %	Possible causes	Scope of test	Test step
0	No voltage or ground at diagnostic socket. Open in wiring of diagnostic socket contact 3. Lambda tester faulty. Mixture set too rich.	Test power supply, ground and diagnostic socket wiring. Test lambda setting.	4.0 – 4.3
10	Air flow sensor potentiometer wrongly connected or faulty. Possibly, fast idling speed.	Test signal from air flow sensor potentiometer and wiring routing.	5.0 – 5.1
20	Full load contact wrongly connected or faulty. 20 % readout only if microswitch operated.	Test full load contact.	6.0 – 6.2
30	Short-circuit or open circuit between CIS-E control unit and coolant temperature sensor or coolant temperature sensor faulty.	Test coolant temperature sensor. Test wiring.	7.0 – 7.4
40	Open circuit or short-circuit to air flow sensor potentiometer or faulty. Possibly, fast idling speed.	Test air flow sensor potentiometer. Test wiring. CIS-E control unit.	8.0 – 8.5
50	O ₂ sensor not operating or faulty. Open circuit.	Engine oil temperature approx. 80 °C. Test O ₂ sensor. Test wiring.	9.0 – 9.3
60	not assigned	-	-

On/off ratio in %	Possible causes	Scope of test	Test step
70	No TD signal (open circuit) at CIS-E control unit.	Test TD signal.	10.0 – 10.2
80	Open circuit or short to ground. Altitude correction sensor faulty.	Test altitude correction sensor and wiring.	11.0 – 11.3
90	not assigned	–	–
100	Lambda setting too lean. O ₂ sensor faulty (short to ground). No voltage or ground at CIS-E control unit or CIS-E control unit faulty. Lambda tester faulty.	Test overvoltage protection. Test ground. Test setting of lambda control and O ₂ sensor signal. CIS-E control unit faulty.	12.0

**f) Electrical test data CIS-E injection system (current at actuator mA)
Model Years 1986 – 1989**

Ignition: ON	Coolant temperature sensor		Post-start enrichment Post-start at + 20 °C	Acceleration enrichment at + 20 °C and blipping throttle	Full load enrichment at approx. 5000 rpm	Part load mixture adaptation	Decel fuel cutoff
	Coolant temperature + 20 °C (warm-up base level) Resistance 2.3 – 2.8 kΩ	Coolant temperature + 80 °C Resistance 290 – 370 Ω					
75	0	0 ± 3	5 – 9	> 20	4 – 6	Reading fluctuates	approx. -60

g) Special tools

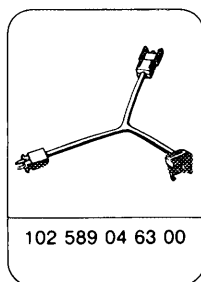

102 589 04 63 00

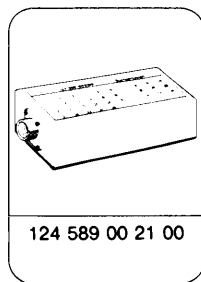

124 589 00 21 00

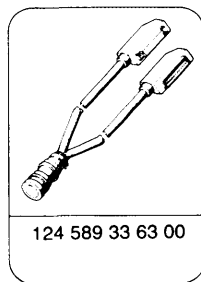

124 589 33 63 00

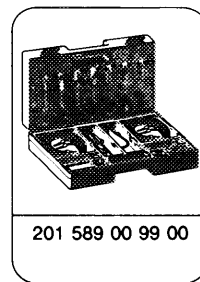

201 589 00 99 00

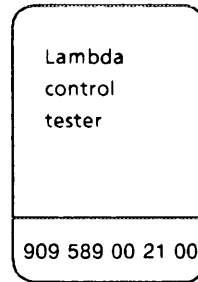

Lambda
control
tester

909 589 00 21 00

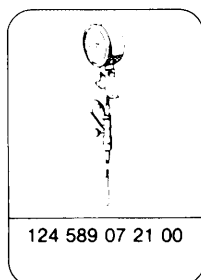

124 589 07 21 00

Commercial testers

Multimeter	e. g. Sun, DMM-5
Twin outlet	e. g. Hermann, ECD 53
Lambda control tester	e. g. Bosch KDJE-P600, ¹⁾ Hermann, L115
Engine tester	e. g. Bosch, MOT 002.02

¹⁾ Special tool 909 589 00 21 00.

h) Connecting testers according to connection diagram

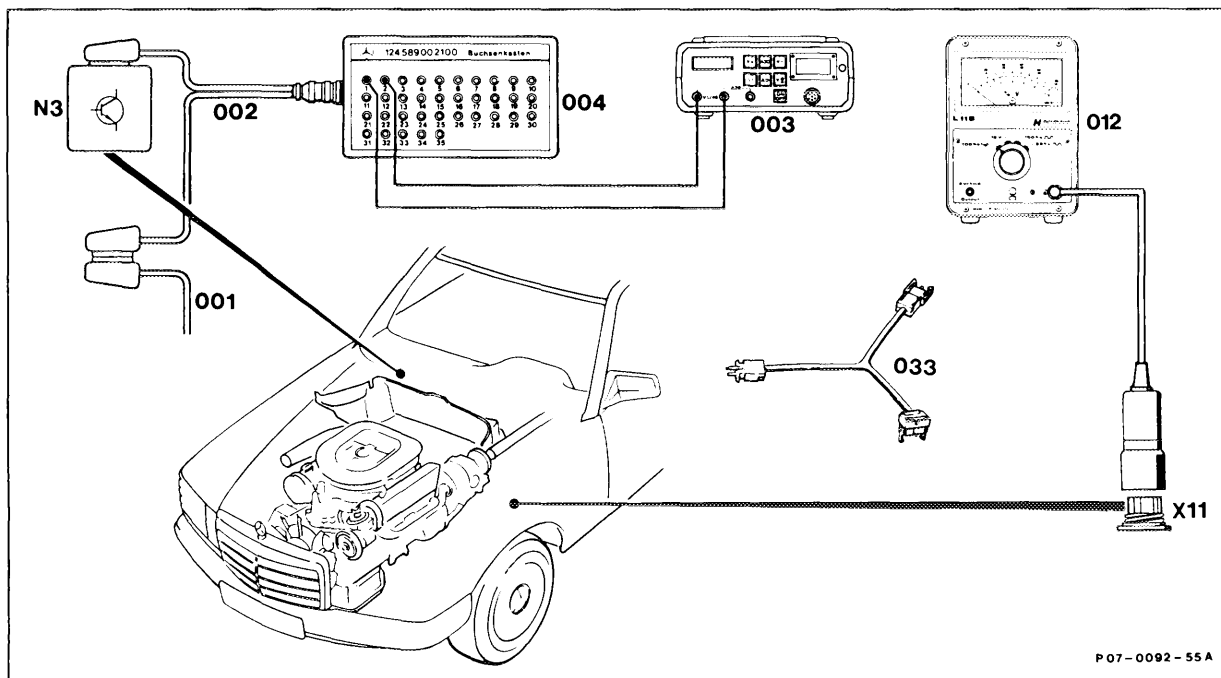

001 CIS-E control unit connector
 002 Test cable
 003 Multimeter
 004 Contact box

012 Lambda control tester
 033 Test cable 102 589 04 63 00
 N3 CIS-E control unit
 X11 Diagnostic socket/terminal block (circuit TD)

i) Pin assignment of CIS-E control unit connector (N3)

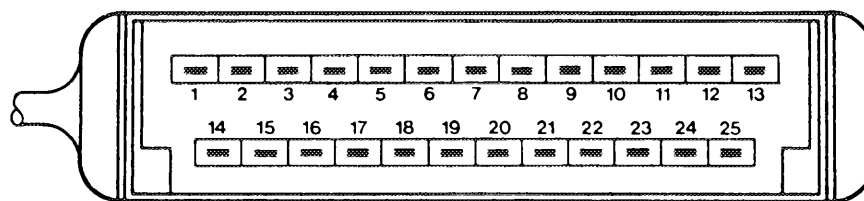







1074-16264



1	Overvoltage protection relay (K1, K1/1), contact 2, terminal 87E	15	CHECK ENGINE indicator lamp (A1e26) (California only)
2	Engine ground (W11)	16	Idle speed control unit (N8), contact 12, gear detection
3	not assigned	17	Air flow sensor potentiometer (B2), contact 2
4	Trip computer plug connection (X61)	18	Air flow sensor potentiometer (B2), contact 3, altitude sensor (B18), contact 3
5	Throttle valve switch (S29/2), contact 3, full load/idle speed detection	19	Exhaust gas recirculation (EGR) temperature sensor (B21),
6	not assigned	20	Model 126: battery ground (W10)
7	Ground from connector 7 is connected internally to ground of connector 2	21	Model 107: main ground, right footwell (W1)
8	Heated O ₂ sensor (G3/2)	22	Coolant temperature sensor (B11/2)
9	Idle speed control unit (N8), contact 2, temperature signal (TF)	23	not assigned
10	Electrohydraulic actuator (Y1), contact 2	24	Diagnostic socket (X11), contact 3, on/off ratio; CHECK ENGINE indicator lamp (A1e26) (California only)
11	Altitude sensor (B18), contact 1	25	Idle speed control unit (N8), contact 1, road speed signal
12	Electrohydraulic actuator (Y1), contact 1		Idle speed control unit (N8), contact 10, TD/TN signal
13	Idle speed control unit (N8), contact 4, idle speed detection		
14	Air injection relay (K17), contact 5, air pump control		

j) Test routine with contact box

Symbols for testers:

	Contact box
	Lambda tester
	Battery
	Multimeter
	Contact
	Connector









Symbols for quantities measured with multimeter:

	Multimeter:	Range Volts DC
	Multimeter:	Range Ohms
	Multimeter:	Range Amperes

Note



If the on/off ratio readout is constant, first perform test steps 1 – 3. If the specified value of a test step, e. g. step 4, is correct, is not then necessary to perform the sub test step 4.1.



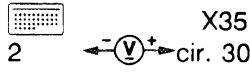
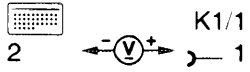
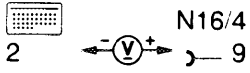
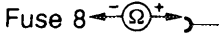
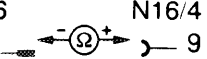
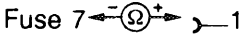
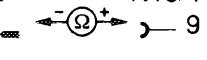

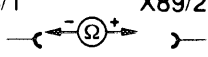
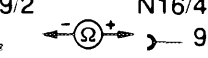

Overvoltage protection relay in Model 107 with designation "K1".

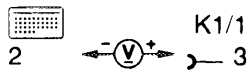
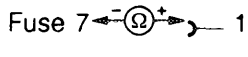
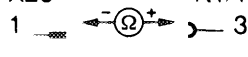
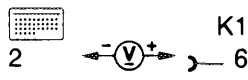
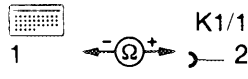
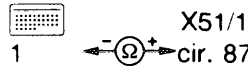
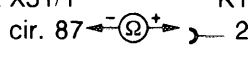

On/off ratio readout	Test step/ Test scope	Tester/ Test connection	Operation/ Requirement	Spec.	Possible cause/Remedy
-	1.0 Ground points	 2  +	Ignition: ON	11 – 14 V	Ground terminal W11 loose, open circuit from N3 → W11
	1.1	 7  +		11 – 14 V	CIS-E control unit (N3) faulty
	1.2	 20  +		11 – 14 V	Ground terminal W10 (Model 107, W1) loose, open circuit from N3 → W10 (Model 107, W1).
-	2.0 Power supply from CIS-E control unit (N3)	2   1	Ignition: ON	11 – 14 V	Fuse in overvoltage protection (K1/1), overvoltage protection (K1/1) faulty or not connected, wiring to contact 1 (terminal 30) interrupted ¹⁾

On/off ratio readout	Test step/ Test scope	Tester/ Test connection	Operation/ Requirement	Spec.	Possible cause/Remedy
	2.1 Test wiring				
	2.1.1 Wiring from terminal 30		Ignition: OFF	11 – 14 V	Model 107: Wiring loose, open circuit from G1 → X35
-	2.1.2		Overvoltage protection (K1/1) disconnected.	11 – 14 V	Model 107: Open circuit from X35 → K1 Contact 1 Model 126: Open circuit from G1 → K1/1 Contact 1
	2.1.3 Wiring from terminal 15		Ignition: ON Fuel pump relay (N16/4) disconnected.	11 – 14 V	Models 107, 126: without ASR Open circuit from F1 → N16/4 with ASR: Open circuit from N4/1 → N16/4
	2.1.4	F1 X26 	Ignition: OFF	< 1 Ω	Model 107: Open circuit
	2.1.5	X26 N16/4 13 		< 1 Ω	Model 107: Open circuit
	2.1.6	F1 X26 Fuse 7 		< 1 Ω	Model 126 without ASR: Open circuit
	2.1.7	X26 N16/4 1 		< 1 Ω	Model 126 without ASR: Open circuit





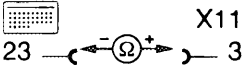
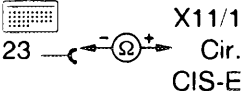
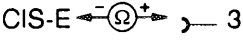
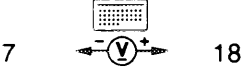



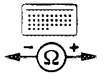
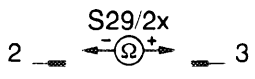
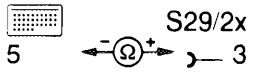
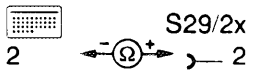

- 1) **Model 126:** Circuit to overvoltage protection (K1/1) contact 3 (terminal 15) interrupted, wiring from overvoltage protection (K1/1) contact 2 (terminal 87E) to CIS-E control unit (N3) contact 1 interrupted.
- Model 107:** Circuit to overvoltage protection (K1) contact 6 (terminal 15) interrupted, wiring from overvoltage protection (K1) contact 2 (terminal 87) to terminal block (X51/1) interrupted, wiring from terminal block (X51/1) to CIS-E control unit (N3) interrupted.







On/off ratio readout	Test step/ Test scope	Tester/ Test connection	Operation/ Requirement	Speci- fication/ Function	Possible cause/Remedy
	2.1.8	N4/1 X89/2 30 		< 1 Ω	Model 126 with ASR: Open circuit
	2.1.9	X89/2 N16/4 		< 1 Ω	Model 126 with ASR: Open circuit
	2.2.0		Ignition: ON Overvoltage protection (K1/1) disconnected.	11 – 14 V	Model 126 without ASR: Open circuit from N16/4 → K1/1
	2.2.1			11 – 14 V	Model 126 with ASR: Open circuit from F1 → K1/1
	2.2.2	F1 X26 Fuse 7 	Ignition: OFF	< 1 Ω	Model 126 with ASR: Open circuit
	2.2.3	X26 K1/1 1 	Overvoltage protection (K1/1) disconnected.	< 1 Ω	Model 126 with ASR: Open circuit
	2.2.4		Ignition: ON Overvoltage protection (K1) disconnected.	11 – 14 V	Model 107: Open circuit from fuse 7 → K1, contact 6
	2.2.5 Wiring terminal 87E		Ignition: OFF	< 1 Ω	Open circuit from K1/1 → N3, contact 1
	2.2.6		< 1 Ω		Model 107: Open circuit from X51/1 → N3, contact 1
	2.2.7	X51/1 K1 cir. 87 		< 1 Ω	Model 107: Open circuit







On/off ratio readout	Test step/ Test scope	Tester/ Test connection	Operation/ Requirement	Spec.	Possible cause/Remedy
-	3.0 Test current at electrohydraulic actuator (Y1).	 set to A.	Test cable 102 589 04 63 00 connected to electrohydraulic actuator (Y1) Ignition: ON Engine idling	75 mA	Electrohydraulic actuator (Y1), wiring, CIS-E control unit (N3), CIS-E reference resistor (R17/1).
	3.1 Electrohydraulic actuator (Y1)	10  12	Disconnect test cable, Ignition: OFF Connector at CIS-E control unit (N3) detached.	fluctuates 0 ± 3 mA	Set lambda control, test O ₂ sensor (G3/2).
	3.2	1  2 Y1	Connector at electrohydraulic actuator (Y1) detached.	19.5 ± 1 Ω	Renew electrohydraulic actuator (Y1).
-	3.3	 10  Y1 2		< 1 Ω	Open circuit
	3.4	 12  Y1 1		< 1 Ω	Open circuit



On/off ratio readout	Test step/ Test scope	Tester/ Test connection	Operation/ Requirement	Spec.	Possible cause/Remedy
0%	4.0 Wiring from CIS-E control unit (N3) to diagnostic socket (X11)	 X11 23 ← Ω → 3	Ignition: OFF Connector at CIS-E control unit (N3) detached.	< 1 Ω	Open circuit at X11 power supply from X11 contact 6 or ground at X11 contact 2 interrupted. Lambda control tester faulty. Open circuit at X11/1 (Model 107 only).
	4.1	 X11/1 23 ← Ω → Cir. CIS-E		< 1 Ω	Model 107: Open circuit from N3 contact → X11/1, terminal CIS-E
	4.2	X11/1 X11 Cir. 3  X11/1 Cir. CIS-E ← Ω → 3		< 1 Ω	Model 107: Open circuit from X11/1, Terminal CIS-E → X11 contact 3
	4.3 O ₂ sensor signal		O ₂ sensor (G3/2) at normal operating temperature	-	Lambda control out-of- tolerance (refer to test step 9).
10%	5.0 Air flow sensor potentio- meter (B2)	 7 ← V → 18	Engine idling	4.5 – 5.5 V	Air flow sensor potentiometer (B2), CIS-E control unit (N3), open circuit from N3, contact 7 → B2, contact 1
	5.1 Wiring	 7 ← Ω → B2 1	Ignition: OFF Measure at connector, air flow sensor potentiometer (B2).	< 1 Ω	Open circuit

On/off ratio readout	Test step/ Test scope	Tester/ Test connection	Operation/ Requirement	Specification/ Function	Possible cause/Remedy
20%	6.0 Full load contact		Ignition: OFF Connector at CIS-E control unit (N3) and connector at electronic ignition control unit code number (1 – 4) disconnected. Accelerator at full throttle	∞ $< 1 \Omega$	– Pins of connector S29/2x wrongly assigned, full load contact, wiring.
	6.1 Full load contact		Detach connector S29/2x. Accelerator at full throttle	∞ $< 1 \Omega$	– Set throttle valve switch (S29/2) or renew, open circuit.
	6.2 Wiring			$< 1 \Omega$	Open circuit
				$< 1 \Omega$	Open circuit

On/off ratio readout	Test step/ Test scope	Tester/ Test connection	Operation/ Requirement	Specifi- cation/ Function	Possible cause/Remedy
30%	7.0 Coolant temperature sensor (B11/2)	7  21	Engine idling.	At + 80 °C coolant temperature 0.29 - 0.35 V. Refer to table "I" for other values.	Coolant temperature sensor (B11/2), wiring.
	7.1 Coolant temperature sensor (B11/2)	 7  B11/2	Ignition: OFF Connector at coolant temperature sensor (B11/2) disconnected.	Refer to table "I".	Model 107, Model 126 up to 08/87: Renew coolant temperature sensor (B11/2).
	7.2	 B11/2	Ignition: OFF Connector at coolant temperature sensor (B11/2) disconnected. Measure diagonally and compare readings with table "I".	Refer to table "I".	Model 126 starting 09/87: Renew coolant temperature sensor (B11/2).
	7.3 Wiring	 21  B11/2		< 1 Ω	Model 107, Model 126 up to 08/87: Open circuit
	7.4	 21  B11/2 2		< 1 Ω	Model 126 starting 09/87: Open circuit
	7.5	 7  B11/2 4		< 1 Ω	Model 126 starting 09/87: Open circuit

On/off ratio readout	Test step/ Test scope	Tester/ Test connection	Operation/ Requirement	Spec.	Possible cause/Remedy
40%	8.0 Air flow sensor potentiometer (B2)	7  18	Engine idling.	4.5 – 5.5 V	Air flow sensor potentiometer (B2), CIS-E control unit (N3), wiring.
		7  17		0.5 – 1.5 V	Air flow sensor potentiometer (B2), CIS-E control unit (N3), wiring.
	8.1 Air flow sensor potentiometer (B2)	1  B2 3	Ignition: OFF Connector at air flow sensor potentiometer (B2) disconnected.	3.6 – 4.4 kΩ	
	8.2	1  B2 2	Slowly deflect air flow sensor plate by hand.	Ω reading increases continuously up to half of deflection and then drops off again.	Renew air flow sensor potentiometer (B2).
	8.3 Wiring	7  B2 1	Ignition: OFF Measure at connector, air flow sensor potentiometer (B2).	< 1 Ω	Open circuit
	8.4	18  B2 3		< 1 Ω	Open circuit
8.5	17  B2 2		< 1 Ω	Open circuit	

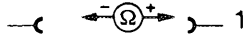
On/off ratio readout	Test step/ Test scope	Tester/ Test connection	Operation/ Requirement	Spec.	Possible cause/Remedy
50%	9.0 Heated O ₂ sensor (G3/2)	7  8	Engine idling, lambda sensor (G3/2) at normal operating temperature.	fluctuates between 0.1 – 0.9 V	Check O ₂ sensor (G3/2), wiring, CIS-E reference resistor (R17/1).
	9.1 Heated O ₂ sensor (G3/2)	7  G3/2x2	Engine idling, plug connection of O ₂ sensor signal (G3/2x2) disconnected and connector contacting ground.	> 450 mV	Renew heated O ₂ sensor (G3/2).
	9.2 Wiring	7  8	Ignition: OFF Connector at CIS-E control unit (N3) disconnected.	∞	Wiring faulty
	9.3	8  G3/2x2		< 1 Ω	Open circuit
60%	Refer to testing speed signal Section "q".				
70%	10.0 TD/TN signal	2  25	Engine idling	6 – 12 V	Ignition control unit (N1/2), (N1/3), wiring.
	10.1 Wiring	25  X11 1	Ignition: OFF	< 1 Ω	Open circuit

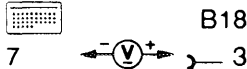
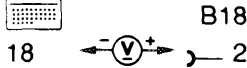
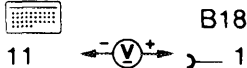
On/off ratio readout	Test step/ Test scope	Tester/ Test connection	Operation/ Requirement	Spec.	Possible cause/Remedy
70%	10.2	N1/2 TD/TN 	Connector (TD signal) at ignition control unit (N1/2) disconnected.	< 1 Ω	Open circuit
80%	11.0 Altitude correction sensor (B18)	7  18	Ignition: ON CIS-E control unit connected	4.5 – 5.5 V	Altitude correction sensor, air flow sensor potentiometer, refer to test step 8 wiring CIS-E control unit
	11.1 Altitude correction sensor (B18)	7  11	-	Refer to table "o"	Altitude correction sensor, wiring
	11.2 Wiring	 B18 7	Ignition: OFF Detach connector (B18)	< 1 Ω	Open circuit
	11.3	 B18 18		< 1 Ω	Open circuit
	11.4	 B18 11		< 1 Ω	Open circuit
90%	not assigned				
100%	12.0	-	-	-	Refer to test steps 1, 2, 3, 9 and test on/off ratio.

I) Table of voltage levels of EZL/CIS-E coolant temperature sensor (B11/2)

Temperature in °C	Resistance	Voltage at contact 11 Intake air (Volts)	Voltage at contact 21 Coolant (Volts)
-20	15.7 kΩ	2.85 – 3.49	3.24 – 3.94
-10	9.2 kΩ	2.50 – 3.06	2.84 – 3.47
0	5.9 kΩ	2.10 – 2.56	2.39 – 2.93
10	3.7 kΩ	1.69 – 2.07	1.94 – 2.37
20	2.5 kΩ	1.32 – 1.62	1.51 – 1.84
30	1.7 kΩ	1.03 – 1.25	1.16 – 1.42
40	1.18 kΩ	0.77 – 0.94	0.88 – 1.08
50	840 Ω	0.57 – 0.69	0.66 – 0.80
60	600 Ω	0.42 – 0.52	0.50 – 0.61
70	435 Ω	0.32 – 0.40	0.38– 0.46
80	325 Ω	0.25 – 0.31	0.29 – 0.35
90	247 Ω	0.18 – 0.22	0.22 – 0.26

m) Testing 4-pole coolant temperature sensor (B11/2)

With two ground terminals, engine ground and CIS-E control unit ground, as well as one terminal for the temperature signals for CIS-E control unit and ignition control unit. The resistances of the characteristics are identical to the two-pin temperature sensor (B11/2).

Temperature sensor and connector are designed (temperature signals crosswise) in such a way that the connector can be fitted in any desired position.

Note

When testing the coolant temperature sensor, the resistances should be measured and compared 2 × crosswise (refer to ill.).

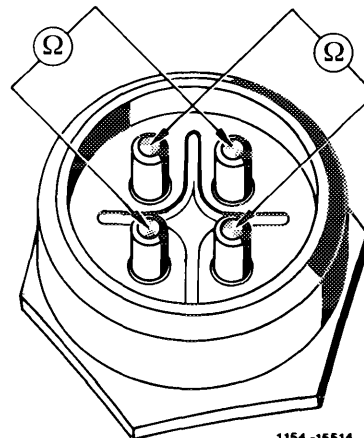

1154 -15514

n) Testing connector of 4-pole coolant temperature sensor (B11/2)

When testing the wiring from the CIS-E control unit (contact 7 and 21, resp.) to connector (B11/2), test the contacts on the connector clockwise. Only one cable should have continuity ($< 1 \Omega$).

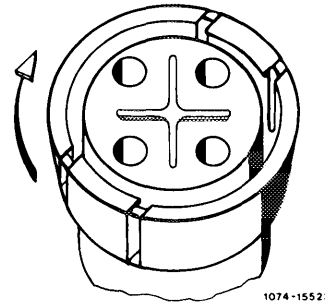

o) Altitude sensor table (B18)

Height above MSL/m	Atm. pressure p absolute mbar	Voltage approx. Volts
0	1013	4 ± 1
1000	899	3 ± 1
2000	795	2 ± 1

p) Testing decel fuel cutoff



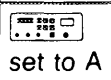

Test conditions:

- Road speed > 20 km/h
- Engine speed > 1440 rpm
- Idle contact of throttle valve switch (S29x2) closed
- Engine at normal operating temperature, oil temperature approx. 80 °C
- Selector lever in drive position

Test step/ Test scope	Tester/ Test connection	Operation/ Requirement	Specification	Possible cause/Remedy
Test decel fuel cutoff	 set to A	Connect test cable 102 589 04 63 00 to actuator, selector lever in position 2, engine speed > 2500 rpm, deceleration (throttle valve closed)	approx. - 60 mA	Idle contact, refer to 07.3-112, test steps 4.0 - 4.2; selector lever position refer to 07.3-112, test steps 6.0 - 6.5, road speed signal refer to Section "q"

q) Testing road speed signal

Refer to Section "h" for contact box connection diagram

Test step	Tester/ Test connection	Operation/ Requirement	Specification	Possible cause/Remedy
1.0 Test road speed signal	2  24	Run car on dynamometer with > 20 km/h	> 1 V	Test electronic speedometer, refer to 54-252, wiring
1.1 Wiring	N8 1  24	Connector (N8) disconnected	< 1 Ω	Open circuit
1.2	N8 1  X26 6	Connector (N8) disconnected, connector (X26) separated	< 1 Ω	Open circuit
1.3	A1p8  X26 6	Connector (X26) separated, connector (A1p8) disconnected	< 1 Ω	Open circuit

B. Modifications and Arrangement of Coolant Temperature Sensors (B11/2)

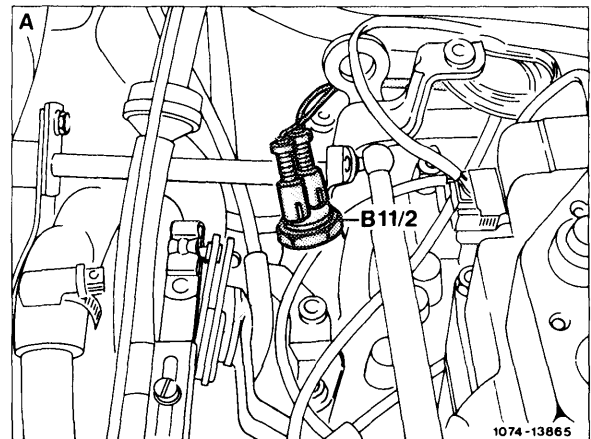

Temperature sensor
Arrangement up to 12/85

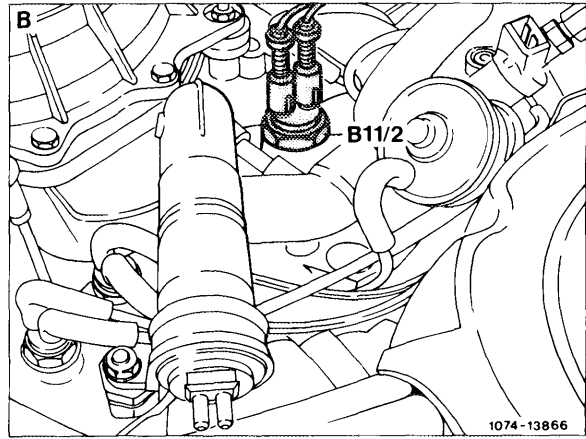

Temperature sensor
Arrangement as from 01/86

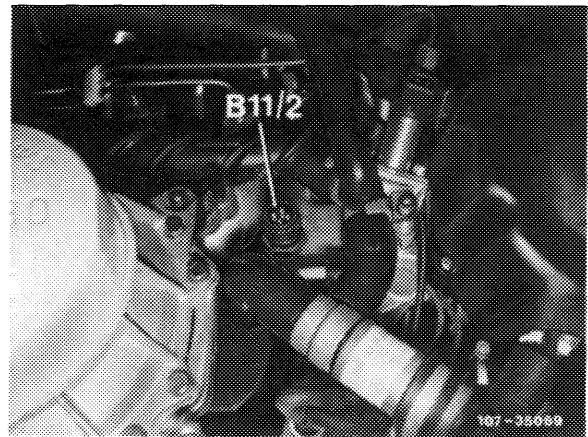

Temperature sensor
California starting 1988,
Federal starting 1990