

14-478 Checking air injection

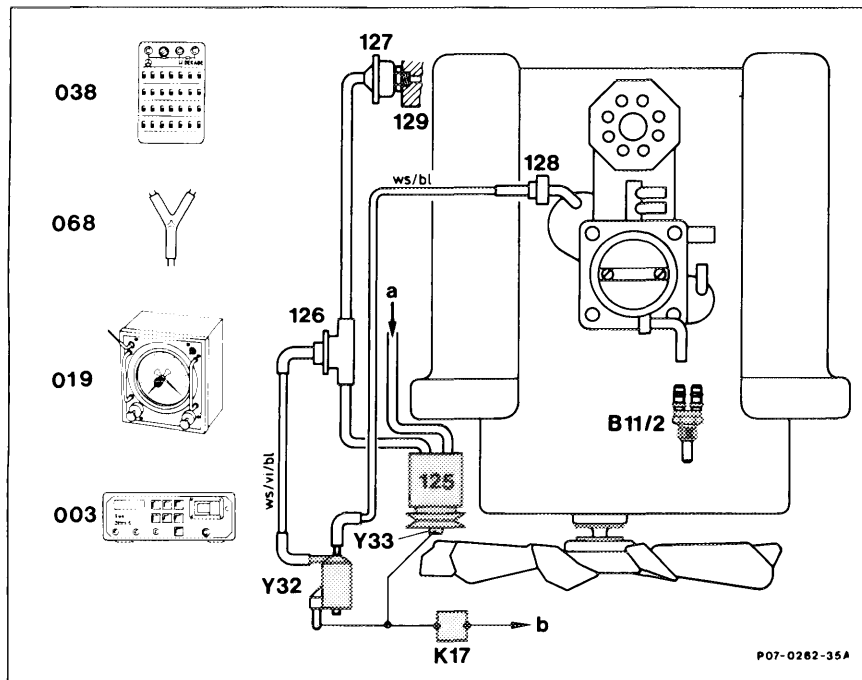

Note

As from 1988 model year California, 1990 model year Federal, the temperature sensor coolant is of the 4-pole type. An NTC for CIS-E and an NTC for EZL.

Both NTC's are independent of each other and are grounded by the EZL ignition control unit and the CIS-E control unit respectively.

The arrangement of the two NTC's is diagonal.

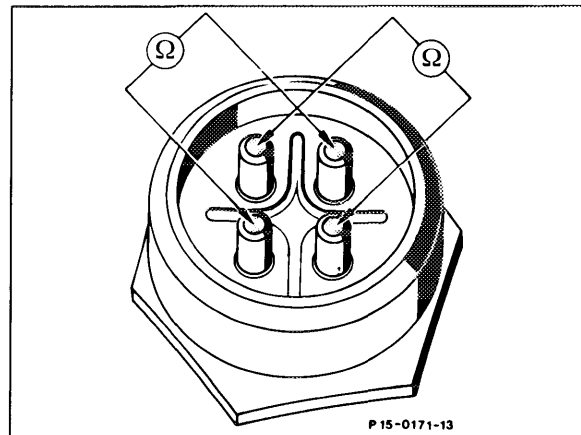

The CIS-E temperature sensor is identified by the following test:

Connect lambda control tester to diagnostic socket. Pull coupling off coolant temperature sensor.

Switch on ignition, display shows 30%. With Ω -decade (038) simulate $2.5\text{ k}\Omega$ ($20\text{ }^{\circ}\text{C}$), connect to two opposite jacks of the coupling (across) (Fig.).

At the connection CIS-E temperature sensor the impulse period jumps to 70%.

The air pump is only activated in the coolant temperature range $17\text{-}70\text{ }^{\circ}\text{C}$.

Test condition:

Coolant temperature $< 70\text{ }^{\circ}\text{C}$.





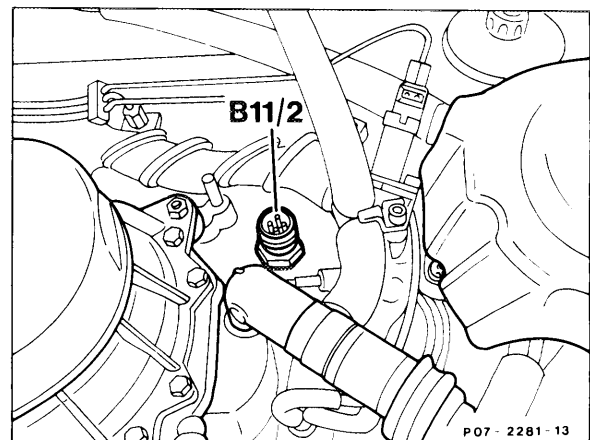

Pull off coupling coolant temperature sensor (B11/2). With Ω -decade, simulate $2.5\text{ k}\Omega + 20\text{ }^{\circ}\text{C}$.

Electrical wiring diagrams (07.3-128).



Test

Explanation of symbols

-  Multimeter
-  Jack
-  Plug
-  Ground
-  Multimeter measuring mode resistance
-  Multimeter measuring mode DC voltage
-  Multimeter measuring mode amperage

Impulse period display	Test step/ Scope of test	Measuring device/ Test connection	Actuation/ Requirement	Set value/ Function	Possible cause/Remedy
-	1.0 Air injection	-	Start engine. Pull shaped hose of air pump off air cleaner and lightly close with finger.	Strong suction on shaped hose.	Check electric change-over valve (Y32), vacuum activation electromagnetic clutch (Y33).
-	2.0 Vacuum activation	Connect vacuum tester with Y-hose (1). With Ω -decade on temperature sensor coolant (B11/2), simulate +20 °C.	Ignition: OFF Pull vacuum line ws/vi bl off change-over valve (Y32). Start engine. Engine speed < 2500 rpm.	Air pump is operational and must switch off after approx. 60 s. Vacuum > 500 mbar.	Vacuum lines electric change-over valve (Y32). Activation air pump (Y33) → test step 9.0.

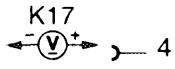
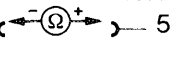
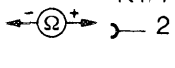
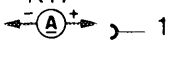
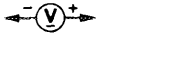
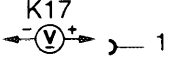
Impulse period display	Test step/ Scope of test	Measuring device/ Test connection	Actuation/ Requirement	Set value/ Function	Possible cause/Remedy
-	3.0 Voltage supply air injection relay (K17)	K17 4 — 	Ignition: ON	11-14 V	Wiring overvoltage protection (K1/1).
-	3.1 CIS-E control unit (N3)	K17 5 —  4	Ignition: ON	11-14 V	Wiring, CIS-E control unit (N3).
-	3.2 Wiring	N3 14 —  K17 5	Ignition: OFF	< 1 Ω	Open circuit.
-	3.3 Wiring	K17 4 —  K1/1 2	Ignition: OFF	< 1 Ω	Open circuit.
-	4.0 Power consumption electromagnetic clutch (Y33)	K17 4 —  1	K17 pulled off. Start engine.	2.5-3.5 A (air suction on shaped hose)	Set values are obtained: Air injection relay (K17) CIS-E control unit, wiring. Above 3.5 A: renew Y33 (14-260), no current (0 A): check wiring to Y33.
-	5.0 Voltage supply air pump	K17 3 — 	K17 pulled off. Ignition: ON	11-14 V	Wiring.
		K17 3 —  1	K17 pulled off. Ignition: ON	11-14 V	Wiring to Y32 and Y33.

Special tool

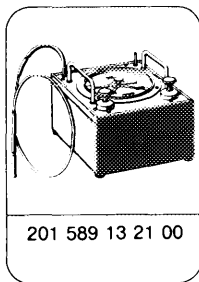

Commercially available tool

Engine tester

e.g. Bosch, MOT 001.03

Shop-made tool

Y-hose

Part No. 117 078 01 45

Line connection on throttle assembly.



The vacuum line ws/br of the exhaust gas recirculation was temporarily connected to the lower connection of the throttle assembly during production start-up (14-050, section "G").

- a to thermostatic valve exhaust gas recirculation
- b to thermostatic valve fuel evaporation system
- c to purge valve
- d to vacuum control valve exhaust gas recirculation (only version "A")

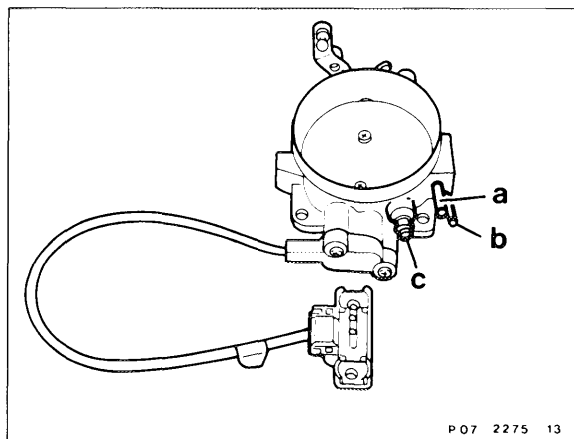

Arrangement exhaust gas recirculation valve (EGR).

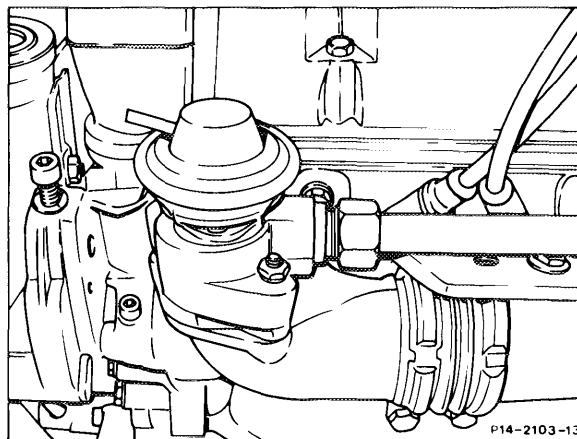



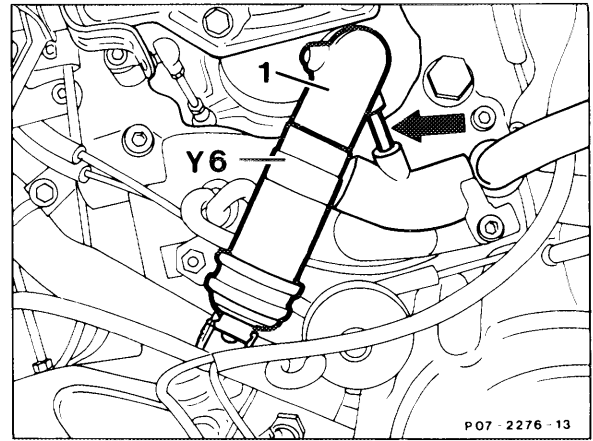

Model 107

Model 126

Arrangement vacuum control valve (90) and
thermovalve (79).



Impulse period display	Test step/ Scope of test	Measuring device/ Test connection	Actuation/ Requirement	Set value/ Function	Possible cause/Remedy
-	5.1 Wiring	K17 1 —  — Y32 2	K17 pulled off: Ignition: OFF	< 1 Ω	Open circuit. Change-over valve air pump (Y32).
-	5.2 Wiring	K17 1 —  — Y33 2	K17 pulled off: Ignition: OFF	< 1 Ω	Open circuit. Electromagnetic clutch (Y33).
-	5.3 Wiring	Y32 1 —  — W10 ⊥	K17 pulled off: Ignition: OFF	< 1 Ω	Open circuit.
-	5.4 Wiring	Y33 1 —  — W10 ⊥	K17 pulled off: Ignition: OFF	< 1 Ω	Open circuit.

Special tools

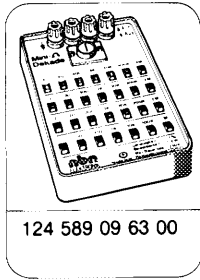

Commercially available testers

Multimeter

e.g. Sun, DMM-5

Lambda control tester

e.g. Hermann, L 115

Shop-made tool

Y-hose

Part no. 117 078 01 45

Arrangement of components

Shaped hose of air pump at side of air cleaner

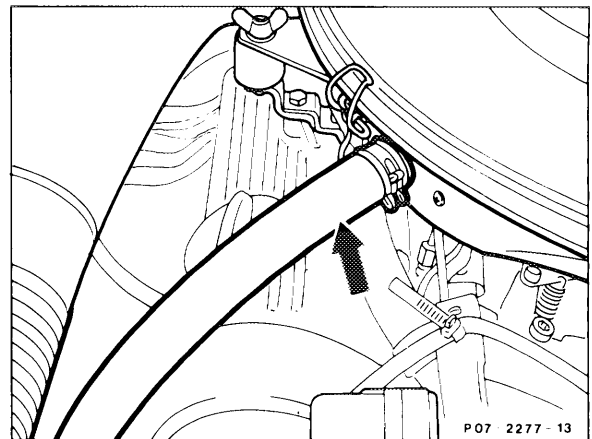

Y33 Electromagnetic clutch

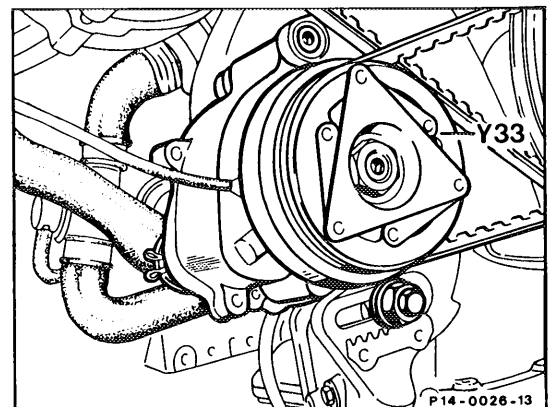

Y32 Change-over valve air injection

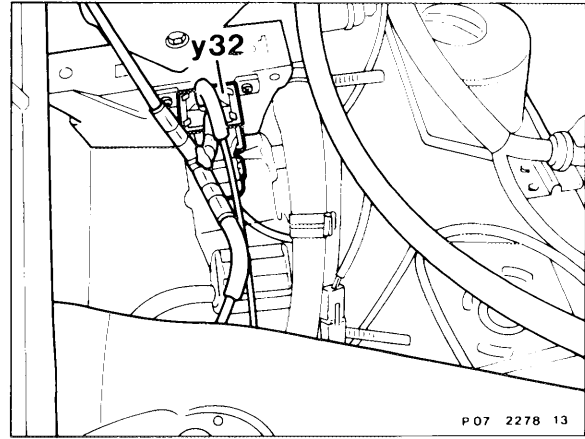

K17 Relay air injection

